

EV ATLANTIS



User Guide EU



Dear Customers,

*We deeply appreciate your business.
Serving you is our highest priority.
We are available for your questions at any time.*

Please Contact:



We wish you many happy moments with your EV ATLANTIS!

From the whole team at E V International Ltd.

Content



Theme	Page
Introduction	2
Scope of supply	3
Safety regulation	4
Technical data	6
Before putting into operation	7
Filling with water	7
Inserting the steam hose	8
Connecting attachments	8
Display	8
Attachments	9
Turning on	10
Directions	11
Ironing	22
EV Steam Brush	24
Air freshener	25
Cleaning and maintenance	26
Legal aspects	27
Maintenance	



Introduction

Your EV ATLANTIS is a result of longtime experience and extensive technological research.

We have created EV ATLANTIS for you as a perfect device and have equipped it with professional accessories.

We firmly believe that you will be happy with our product for many years. For proper operation of EV ATLANTIS please read this user guide.

150 °C - 170 °C (305 °F - 340 °F) hot, dry steam means:

- ▶ dissolving fats;
- ▶ disinfection;
- ▶ bacterial eradication;
- ▶ odor neutralization;
- ▶ human health and environment protection from chemicals.

But above all it is easier, faster, better and more eco-friendly way of cleaning!

Having EV ATLANTIS means that you have purchased an appliance that can be handled quickly and efficiently.

Thanks to the three-tier steam control EV ATLANTIS can be used for gentle cleaning of all types of surfaces.

EV ATLANTIS is designed for cleaning with dry steam. The steam and high temperature easily remove troubling stains, hard water spots, stubborn dirt, grease etc.

Important!



Dear customers of E V International Ltd., please keep the ORIGINAL PACKAGING.

Claims for guarantee repairs can be accepted only in this PACKAGING.

For devices that are not sent in the ORIGINAL PACKAGING the company is not liable for possible damage during transportation.

Scope of supply



 Steam hose	 Universal brush	 Triangular brush	 Point nozzle	 Extension pipes
*  Stainless steel wool				 Plunger - Drain opener
*  Thermofiber towel				 Round nylon brush /small and large/
*  Air Freshener				 Round soft brush
*  Iron				 Round copper brush
*  Steam brush				 Round INOX brush
 Boiler key				 Universal and Triangular brushes mat

* Accessories, which are not included in the kit. To obtain optional accessories, please, contact your authorized sales representative of E V International Ltd. Thank you!



Safety regulations

Strict compliance with the instructions and maintenance recommendations is at the basis of the intended conditions of use. In improper use or non-compliance with the operation instructions any kind of warranties are terminated.

Before putting into operation

Unpacking the appliance

Once you have removed the device from the package, check it for any obvious damage. If you have any doubts do not use the appliance and contact your service center.

Save the packaging by all means because the device is accepted for repairs only with its original packaging.

- ▶ The appliance must be used only for the purpose for which it is intended.
- ▶ Prior to using the appliance read completely and carefully this User Guide.
- ▶ Any use of the appliance contrary to the instructions in this User Guide will void the warranty.
- ▶ The electrical equipment to which this device will be connected must meet the valid safety instructions.
- ▶ Do not use the appliance in extreme temperatures. The ambient temperature should range between +5 °C and +40 °C (40 °F and 105 °F).
- ▶ Before connecting the appliance to the electricity network, make sure that the contact is safe enough

and grounded. You can see the power consumption of the appliance on the manufacturing label on the bottom of the appliance.

- ▶ Do not leave the appliance unattended. Even in brief work breaks pull out the plug from the socket.
- ▶ Before starting any kind of work on the device pull out the plug from the socket.
- ▶ Do not pull out the plug from the socket by pulling the cord of the appliance.
- ▶ Protect the power cord from twisting, damage or passing over sharp edges. Keep it away from heat sources.
- ▶ Do not use the appliance if the power cord or the appliance is damaged.
- ▶ Do not use an extension cord without a control sign and do not use cable reels in any case.
- ▶ If you need to change your power cord, contact your service.
- ▶ The device is equipped with a thermal switch protection that can be activated or changed only by E V International Ltd. company authorized service center.
- ▶ If the device is damaged or it does not function properly it must be immediately turned off. Avoid any interventions.
- ▶ For any kind of repairs, contact E V International Ltd. or your supplier.
- ▶ If the power cord of the device is damaged it should be immediately changed by the manufacturer or an authorized service center.

Safety regulations



- ▶ Never use the appliance with wet hands or feet.
- ▶ Do not use the appliance within walking distance of sinks, tubs, showers or water reservoirs.
- ▶ Do not immerse the appliance, its cord or plug in water or other liquids.
- ▶ In case of danger of explosion using the appliance is forbidden.
- ▶ Do not use the appliance within walking distance of toxic substances.
- ▶ Do not use the appliance on heat-sensitive surfaces or objects.
- ▶ Do not expose the appliance to the impact of weather conditions.
- ▶ Do not place the appliance near working heaters, electric heaters or near heat sources.
- ▶ Electric devices such as televisions, radios, lamps, etc. should not be cleaned with steam, even when they are not connected to the electricity network.
- ▶ Do not allow the appliance to be operated by children.
- ▶ **Do not use excessive force or sharp objects to press the buttons. Just touch the display.**
- ▶ Always place the appliance on a stable ground.
- ▶ If the appliance is dropped from height and/or damaged, do not use it and contact your supplier.
- ▶ In case of damage turn off the appliance and never attempt to repair it by yourself. Contact your service center.
- ▶ During repairs use only genuine parts.
- ▶ Always keep the appliance in horizontal position.
- ▶ Do not direct the steam jet in or towards electrical appliances.
- ▶ Before cleaning the appliance always pull out the plug from the socket.
- ▶ Always wait the appliance to cool down before storing.
- ▶ Please empty the boiler if the appliance is not used more than three weeks.
- ▶ This appliance is available with several safety systems that can be changed only by an authorized service.
- ▶ Never direct the steam jet at people or animals.
- ▶ Never place your hand in front of the steam jet.
- ▶ **Never pour abstersgents or other additives in the tank for steam generation. Use only tap water.**
- ▶ This appliance is not suitable for use by persons (including children) with reduced physical, sensory or mental disabilities or who have no experience or knowledge of the use of the device.
- ▶ Make sure children never play with the appliance.
- ▶ Not for Space heating purposes.



Technical data - EV ATLANTIS

▶ Power supply	220 - 240 V - 50/60 Hz
▶ Max. total working power	2850 W
▶ Max. boiler power	2000 W
▶ Max. iron power	850 W
▶ Boiler capacity	2.2 l (0.58 gal)
▶ Capacity of the refilling tank	2.1 l (0.55 gal)
▶ Maximum pressure	8 bar
▶ Test pressure	10 bar
▶ Weight	6,5 kg (14lb)
▶ Steam control	Electronic
▶ Size	410 x 297 x 250 (16 x 12 x 10 in)
▶ Body	100% AISI 304 INOX- Stainless steel (lifetime warranty against rust)

Protective devices:

- ▶ Overpressure valve;
- ▶ Protection class IP 24;
- ▶ Electronic control of the heating power;
- ▶ Electronic control of the water level in the boiler;
- ▶ Electronic control of the water level in the refilling tank;
- ▶ Electronic control of the voltage in the appliance socket;
- ▶ Automatic control of the functions for each connection;
- ▶ Thermostat with automatic recharge;
- ▶ Thermostat "One-shot".



* Maximum pressure is the pressure at which the safety valve is activated at the latest. It does not correspond to the operating pressure.

Before putting into operation



Description of the appliance and an explanation of the figures

1. Boiler screw cap
2. Tank
3. Tank cap
4. Touch screen display
- 4.1 Shortage of water: H₂O appears on the display + acoustical signal
- 4.2 Steam is ready: 170 °C (340 °F) appears on the display
5. Power cord winder
6. Plug socket

1. Filling EV ATLANTIS with water

Before inserting the plug into the outlet, make sure that the boiler cap (1) is tightened completely.

Fill the tank (2) with 2 L (0.52 gal) tap water.

Touch the main switch on the touch screen display (4) to turn on the EV ATLANTIS.

Now the appliance pumps the water into the boiler.

The appliance is equipped with a warning acoustic signal that indicates when cold water must be poured into the tank (2). Shortage of water: When in shortage of water: H₂O appears on the display (4).



In case of water shortage steam output is interrupted so that the boiler under pressure is off and not idle.

If EV ATLANTIS needs water, remove the tank cap (3) and fill up the tank (2) with the plastic bottle.

Never pour detergents, anti-scale additives, essences or distilled water into the tank (2)!

Doing so would result in serious damage to the water circulation system and heating element.



Connecting attachments

2. Inserting the steam hose into EV ATLANTIS

The protective cover of the plug socket (6) is lifted up. Now you have to insert the plug of the steam hose into the socket. Now, the hose is connected to the appliance.

To remove the steam hose open the lid of the plug socket (6) and pull out the hose.

Always disconnect the hose from the unit after exploitation.

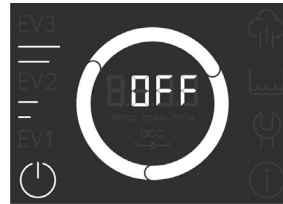

Switch on the appliance by touching the main switch on the display (4), now the boiler is turned on.

Now the appliance pumps water into the boiler.

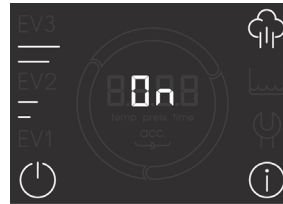

The appliance needs about 3-5 minutes to convert the water into dry steam.

3. Connection of accessories for EV ATLANTIS

Insert the appropriate accessory into the hose or pipe until it locks.

To remove the accessories from the hose or pipe, press the black button and pull out the accessory.



Once it reaches operating pressure, this appears on the display (4). In this way, the appliance shows that it is ready for use.

4. Display for EV ATLANTIS

 ON/OFF

 Heating up the water in the boiler

 Need to refill the tank with tap water

 Service maintenance

 Info about the temperature, pressure and the working time of the unit

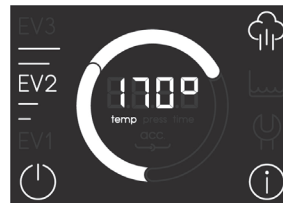

The circle is filled as an indicator when increasing the amount of steam EV1, EV2, EV3.



When you attach an accessory, this symbol  will appear on the display.

Attachments



Cleaning with hot water. You can choose the steam level by pressing button (B) EV1, EV2, EV3. Press and hold button A, then press the steam trigger in the front of the hose and start using the water ejection function.

Firmly press the stainless steel sponge to the big round brush.



Triangular brush + Universal brush + Thermofiber = Universal and triangular brush with thermofiber.
The brush mat provides moisture reduction and temperature accumulation.



Turning on

The appliance must be filled with water.

Now activate the main switch on the touch screen (4); Boiler ON appears on the display (4), the appliance signals that it is ready for use.

Now connect the steam hose.

The appliance has a three-tier steam control.

Your appliance EV ATLANTIS except dry steam function has also a function for hot water under high pressure. For activation of this function you should press and hold button (A). Use the hot water function with medium or large amount of steam. Now the hot water function is at your disposal. It helps to remove dissolved impurities. Especially the guide rails of showers and overflow of sinks and basins. This function is also applicable for cleaning your garden furniture, etc.

Note that this function is only intended for short-time work.



You can regulate the steam level by pressing button (B). No steam, EV1 Small, EV2 Medium, EV3 Large amount of steam.

The hoses into the unit and the steam hose are cold, therefore you need to release the condensation from the hoses by releasing steam at full power for 10 seconds. Please wait until the temperature reaches again about 170 °C (340 °F).

After you have finished the cleaning, switch off the appliance from the main switch on the touch screen display (4).

Now pull the plug from the outlet and curl it around the place for winding the power cord (5).





You can activate and deactivate the steam jet by pressing button (C).

Before storing the appliance, it must be cooled down about 30 minutes (at room temperature).



Directions



Use	Accessories	Amount of steam
<p><u>Absorbers</u></p> <p>Depositions of grease are difficult to remove.</p>	 <p>Use the point nozzle to clean the grease from the filters. Clean the absorber from the outside depending on the access opportunities. For this purpose you can use the triangular brush with thermofiber cloth stretched on it.</p>	<p>Medium, large amount of steam</p>
<p><u>Armature</u></p> <p>Limestone is easily deposited on armature and often it is very difficult to remove.</p>	 <p>Use the point nozzle and the small round copper brush for sensitive or stainless steel surfaces. For deposits of limestone apply a mild pressure with the brush. Deposited with years limestone cannot be removed immediately. Clean the armature regularly.</p>	<p>Medium, large amount of steam</p> <p>This way you save on purchasing spare parts and you no longer need chemicals.</p>
<p><u>Garden furniture</u></p> <p>Garden furniture gets very dirty particularly from insects and lichens.</p>	 <p>Use the point nozzle with the nylon or soft brush. For cleaning wooden furniture choose less steam than for plastic or metal furniture.</p> <p>For cleaning sensitive garden furniture (e.g. wood) use only the soft brush.</p>	<p>Small, medium amount of steam</p> <p>Great amount of dirt will be dissolved.</p>





Directions

Use	Accessories	Amount of steam
<p><u>Shower cabin</u></p> <p>If there are significant limestone deposits on glass doors we recommend using some vinegar for descaling of the limestone. Let it work for approximately 30 minutes.</p>	 <p>For joints and chutes use the point nozzle with the round nylon brush with maximum amount of steam. Clean the rubber seals with less steam.</p>	<p>Medium, large amount of steam</p> <p>For rubber seals, glass, joints and plastic surfaces there are numerous possibilities for use.</p>
<p><u>Wooden furniture</u></p> <p>Wooden furniture and wooden ceilings are very sensitive. Please clean very carefully.</p>	 <p>Treat the wooden kitchen with the point nozzle with less steam from distance of about 15 cm (5 in). For especially sensitive material wipe with a thermofiber cloth soaked with steam. The cleaning is not carried out very quickly, but it is very gentle. For sealed wooden ceilings use universal brush and thermofiber cloth.</p>	<p>Small amount of steam</p> <p>Clean the surface quickly. Do not hold the steam jet at one point. Just a small amount of steam.</p>
<p><u>Ceramic hot plates / ovens</u></p> <p>Fast and effective cleaning of burned fats on the ceramic plates.</p>	 <p>For stubborn stains on ceramic plates or in the oven (not of stainless steel) use the large round brush with stainless steel wool. Then use the point nozzle and wipe with thermofiber.</p>	<p>Medium amount of steam</p> <p>This way you save on purchasing spare parts and you no longer need chemicals.</p>



Directions



Use	Accessories	Amount of steam
<p><u>Animal cages</u></p> <p>Baskets for dogs and cats, cages for birds, cages for hamsters and more.</p>	 <p>Clean the cages with the nozzle point and attached small or large round nylon brush.</p>	<p>Small, medium amount of steam</p> <p>For removal of old and stubborn stains you must repeat the procedure. With the steam you will achieve very good disinfection.</p>
<p><u>Cork</u></p> <p>Treated with oil or wax cork coatings can be cleaned with steam. Sealed cork floors can be cleaned perfectly with steam.</p>	 <p>Place the thermofiber on the universal brush and clean with a small amount of steam. Be careful not much moisture to be soaked in the cork. Slide evenly and quickly on the surface, and do not hold at one place. In case of spots better do it a few times.</p>	<p>Small amount of steam</p> <p>Use only small amount of steam.</p>
<p><u>Plates of cooking stoves</u></p> <p>Dried fats and stains from sauce and water always have to be removed from the cooking stove plates.</p>	 <p>Release steam with the point nozzle on a thermofiber towel and rub with it the stove plate. For stubborn stains, you can use the stainless steel sponge and the big round nylon brush.</p>	<p>Medium amount of steam</p> <p>You may need to repeat the operation in case of burned residue.</p>





Directions

Use	Accessories	Amount of steam
<p><u>Varnished surfaces</u></p> <p>Varnished surfaces can be cleaned very well.</p>	 <p>Treat the surfaces with a small amount of steam at 10-15 cm./ (3-5 in) distance. Then wipe it with the thermofiber. You will get shiny lacquered surfaces without lines.</p>	<p>Small amount of steam</p> <p>Clean the surface quickly. Do not hold the steam jet at one point. Use only small amount of steam.</p>
<p><u>Linoleum</u></p> <p>Ideal material for cleaning with steam.</p>	 <p>In case of heavy soiled areas select medium amount of steam. Along with normal dirt here it is also important to know that the smaller amount of steam makes the surfaces dry faster.</p>	<p>Small, medium amount of steam</p> <p>Repeat the cleaning process to remove the residual quantities of detergents.</p>
<p><u>Mattresses</u></p> <p>The mattresses can be cleaned very well with steam. Here they benefit from the natural freshness of steam cleaning. As a result of the outflow of fluids mattresses start smelling unpleasantly and do not produce sensation of freshness.</p>	 <p>Treat the front and the back of the mattress with the universal brush. Select a small amount of steam. In case of spots you can briefly choose a medium amount of steam. Replace the strained thermofiber before the absorbed moisture to be soaked by the mattress. After cleaning ensure enough ventilation in the room to help the mattress to dry.</p>	<p>Small amount of steam</p> <p>Cleaning with steam kills mites. This is another plus for people allergic to dust mites.</p>

Directions



Use	Accessories	Amount of steam
<p><u>Metal</u></p> <p>Stainless steel, anodized aluminum, perforated sheet, brass and others.</p>	 <p>Depending on the size of the surface choose the point nozzle or the triangular brush (then polish with the thermofiber) or the triangular brush with thermofiber strained on it.</p>	<p>Small, medium amount of steam</p> <p>Use small amount of steam for less humidity on the metal.</p>
<p><u>Carpets</u></p> <p>You can clean and maintain carpets and moquettes without causing any damage. There are materials such as synthetic that can be cleaned smoothly. Other materials are more or less sensitive.</p>	 <p>Vacuum the dust from the entire area before steam cleaning. Check the resistance of colors and the adhesion by doing a test cleaning on small hidden place. After assessing the result and making sure that it is good, continue with the cleaning process. First treat the stains with a point nozzle with steam under obtuse angle (without touching the tip of the nozzle on the carpet) and mop up the separate spots with a towel. Then clean with a small amount of steam and with the universal brush.</p>	<p>Small, medium amount of steam</p> <p>Great for people and hotel customers allergic to dust mites or establishments where pets are allowed. The carpet should be cleaned more often. This way you remove the mites and pet hair.</p>



Directions

Use

Parquet and floor laminate

For parquet floors different types of wood is used, such as beech, oak, maple, ash, birch and many others. Solid wood or finished parquet can be cleaned smoothly with steam if the sealing is not damaged.

Accessories



For cleaning parquet flooring use the universal brush with stretched thermofiber on it. Clean with a small or medium amount of steam. Slide evenly on the surface. Replace the thermofiber on time before the moisture soak into the floor.

Question: Does the steam really cause no damage to the flooring?

Answer: When used properly - Yes, it does not cause any damage to the flooring!

EV ATLANTIS is characterized with extremely dry steam. Only the wet steam could carry the temperature too fast and so it would damage the surface.

(In a sauna we can stand at 90 °C (194 °F), as normal bathing at the same temperature with water would be impossible). Therefore you use much less moisture than with wet wiping. Your parquet flooring shines and you can immediately go back over on it.

Amount of steam

Small, medium amount of steam

Plastic

Plastics can be found in the whole household. Worktops, PVC flooring, kitchen cupboards, lampshades and more.





For lower soiled areas clean with a little amount of steam, so that the surface can dry faster. For heavily soiled areas you can easily clean with medium amount of steam. Plastic is very durable. You can choose from the accessories depending on the surface size.

Small, medium, large amount of steam

With this hygienic procedure you can clean most of the working surfaces in the kitchen.



Directions



Use	Accessories	Amount of steam
<p><u>Radiators</u></p> <p>There are smooth and ribbed radiators.</p>	 <p>Clean smooth radiators with the triangular brush with thermofiber strained on it. Then take down the upper grid and clean the radiator with steam from above. Ribbed radiators and their intermediate spaces are cleaned with the point nozzle. The dust moistens and falls down.</p>	<p>Small, medium, large amount of steam</p> <p>Put behind and under the radiator an old cloth. Dust is collected even better with dust gauze.</p>
<p><u>Window frames</u></p> <p>Profiles, drainage grooves and gaps are cleaned very difficult with common means and that takes too much time.</p>	 <p>For cleaning profiles use the point nozzle with or without a brush attachment. Dissolve the dirt with a little steam and the inaccessible places and then rub with the thermofiber.</p>	<p>Small, medium amount of steam</p> <p>For wooden profiles process with just a small amount of steam.</p>
<p><u>Plants</u></p> <p>Special green plants and dry plants.</p>	 <p>Place a towel under the plant to absorb dust and moisture. Treat the plant with average steam with point nozzle from a distance.</p>	<p>Small, medium amount of steam</p> <p>No more complex watering with shower for the flowers in the tub or in the garden.</p>





Directions

Use	Accessories	Amount of steam
<p><u>Rattan</u></p> <p>Cleaning the dust from rattan furniture and knitted armchairs is difficult.</p>	 <p>Treat knitted furniture with the point nozzle and little steam and then wipe with thermofiber.</p>	<p>Small, medium, large amount of steam</p> <p>Keep a cloth behind the braid to absorb the deposited dust.</p>
<p><u>Sanitary spaces</u></p> <p>Bathtubs, bidets, shower trays, toilets, sinks and more.</p>	 <p>Clean larger surfaces with the large rounded brush. Use the point nozzle for the corners with or without attached brush. For cleaning plastic sinks and tubs use the nylon or the soft brush.</p>	<p>Small amount of steam</p> <p>Thanks to steam cleaning your sanitary ceramics will acquire mirror-smooth glare.</p>
<p><u>Siphons</u></p> <p>Cleaning the drain of showers, bathrooms and kitchens without heavy dismantling of the siphon and without any chemicals.</p>	 <p>Keep the point nozzle or the plunger over the siphon. Then rinse with clean water.</p>	<p>Large amount of steam</p> <p>Quickly and without any chemicals.</p>



Directions



Use	Accessories	Amount of steam
<p><u>Car windows</u></p> <p>During rain deposition of silicone and dirt causes the formation of lines. The result is poor visibility.</p>	 <p>Use the point nozzle and then rub with thermofiber. Keep a distance of minimum 2 cm (1 in) to the multilayer safety glass (e.g. car windscreens).</p>	<p>Medium amount of steam</p> <p>Clean windows are safe windows.</p>
<p><u>Glass</u></p>	 <p>The more dirt on the glass, the less distance between the point nozzle and the surface you need. Short distance means better cleaning with high temperature. Yet avoid direct contact of the surface with the point nozzle. Dissolve the stubborn dirt with the soft brush.</p>	<p>Small amount of steam</p> <p>Optional: you can clean glass surfaces with the universal brush and thermofiber.</p>
<p><u>Upholstery</u></p> <p>Upholstery is made from a variety of materials such as dralon, viscose, cotton, blended fabric, leather and more. Moreover it depends whether or not the material fades. Here in general applies the following: perform a test cleaning. Clean a small surface, and then let it dry.</p>	 <p>Dralon and other non-sensitive materials for upholstery you can clean directly with the triangular brush and thermofiber strained on it. Treat cotton, blended fabrics, etc., from distance of about 15 cm (5 in). And then wipe with thermofiber the surface treated with steam.</p>	<p>Small, medium, large amount of steam</p> <p>Clean your upholstery regularly and the refreshed colors will look amazing.</p>





Directions

Use	Accessories	Amount of steam
<p><u>Car upholstery</u></p> <p>Different materials are used for car upholstery. So please do a test cleaning on a hidden place (for example on the bottom).</p>	 <p>Always watch out for having sufficient distance to the material.</p>	<p>Small amount of steam</p> <p>Move the triangular brush several times briefly over the surfaces. Regular maintenance leads to long-term result.</p>
<p><u>Toilets</u></p> <p>Hinges of glasses, toilet edges and inaccessible corners.</p>	 <p>For cleaning the edges of toilets use the point nozzle with or without a brush. Repeated cleaning removes the yellowing spots of urine. Meanwhile, run the water from the toilet to wash out the different dirty areas. Keep a towel behind the hinge, respectively behind the rakers of the toilet and clean with the point nozzle at full steam. Disinfection of the nozzle after cleaning the toilet is achieved through its steam treatment with the steam hose.</p>	<p>Small, Medium, Large amount of steam</p>

Directions



Use	Accessories	Amount of steam
<p><u>Tiles / grout</u></p> <p>There are many different types of tiles. Almost each tile can be cleaned very well with your EV ATLANTIS.</p>	 <p>Clean your tiles with the universal brush with strained thermofiber. Select a small amount of steam, so tiles can dry faster. For stubborn stains you can process with a large amount of steam and a nylon brush.</p>	<p>Small, medium amount of steam</p> <p>Now without much efforts you can make the steam works. You will be amazed how easy it is.</p>
<p><u>Sensitive surfaces</u></p>	 <p>For cleaning sensitive surfaces a test clean on a hidden place is recommended. Always watch out for having sufficient distance to the surface. The soft brush is particularly suitable for dirt removal of surfaces that are sensitive to thermal treatment. At the end rub the surfaces with thermofiber.</p>	<p>Small, medium amount of steam</p> <p>After a short exercise you will be delighted from the result of this type of cleaning. Have in mind processing with less steam.</p>
<p><u>Blinds</u></p> <p>Clean efficiently blinds in rooms and outside.</p>	 <p>If you press too much, you can bend the blinds, so clean them carefully! Clean outer shutters with universal brush with thermofiber from the outside.</p>	<p>Small amount of steam</p>



Ironing

Instructions

Before using, the iron must be connected to EV ATLANTIS. This symbol will appear on the display  .

Before using the iron, read the instructions.

Do not leave the iron unattended while connected to the appliance. Always leave the iron on the supplied rubber mat.

The iron plate can be damaged if the hot iron is placed on another surface, but the rubber mat. If the iron is placed on improper surfaces, they can be damaged or burned.

Description

The iron is equipped with the following features:

- (A) Steam button
- (B) Rotating button for fabric selection (temperature control)
- (C) The iron is connected with the EV ATLANTIS device through the connecting cable

Accessories

The iron is equipped with the following accessories:

- (D) Rubber mat

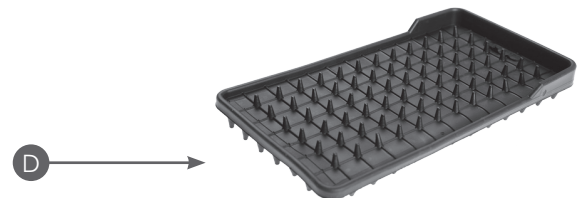
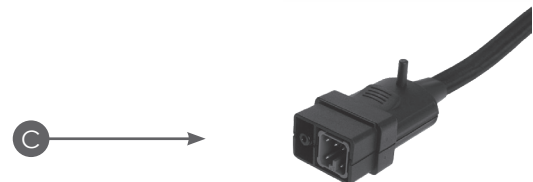
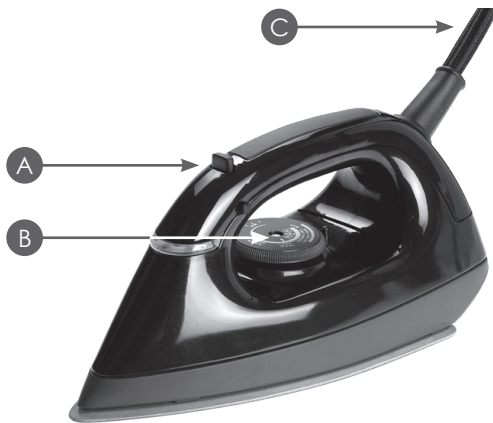

Assemble the accessories as shown in the figure.

Ironing



Connecting and turning on

In order to facilitate your work, we recommend always using the rubber mat. In any case you have to take in mind that here you must always use higher temperature.

Connect the iron through the connecting cable (C) with EV ATLANTIS and turn on the appliance. Adjust the rotary switch position according to the fabric to be ironed.



- Synthetic / silk
- Wool
- Cotton

Steam ironing



Press (A) button to release steam. Steam ironing is possible when the regulation button is at wool ●● or cotton-linen ●●●.

Vertical ironing



Steam output is independent of the iron slope. Therefore, the steam can be used for refreshment of curtains, clothing and fabric upholstery by vertical ironing.

Dry ironing



The heat iron operation does not depend on the condition of the heating boiler, so you can iron without steam.

Vertical position



During ironing you can leave the iron in vertical position (see figure).



Ironing with EV Steam Brush

Instructions

1. Connect the steam brush to the EV unit.
This symbol will appear on the display .

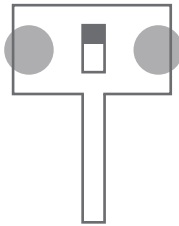

2. Turn on your EV unit and wait until the work temperature reaches 170 °C.
3. Wait 2-3 minutes for the Steam brush to heat up.
4. The Steam brush is ready to use.
5. Push the left or right button to release steam.

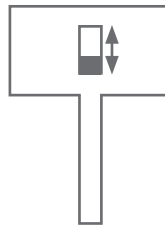

6. Push the black button in the middle and pull it back for continuous steam outlet.
7. After use, turn off the EV unit and disconnect the Steam brush.

Air Freshener

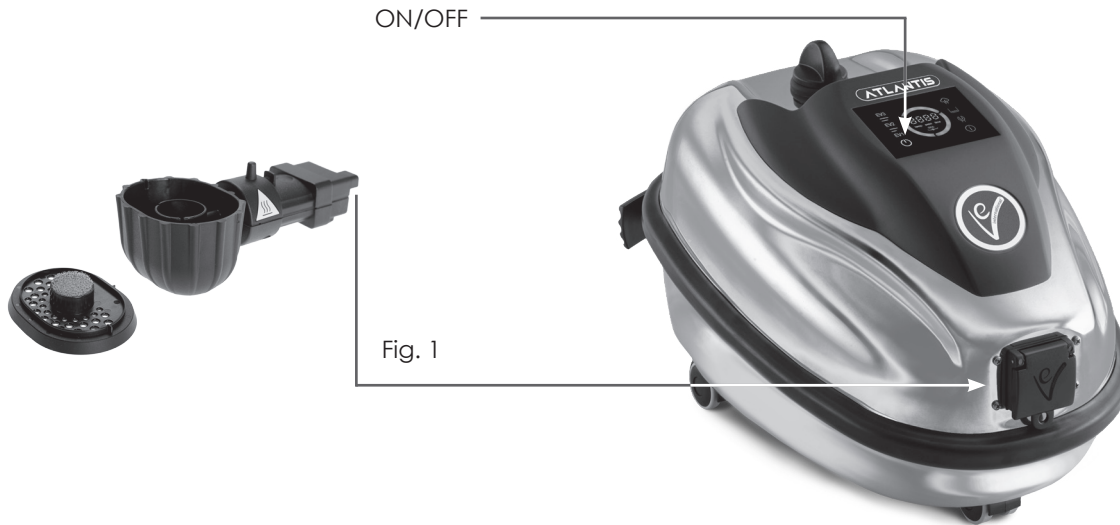

Air freshener use (option)

Before using the air freshener wait until the machine heats up to operating temperature. Connect it to the appliance as shown in Fig. 1. This symbol will appear on the display  .

Note that the air freshener does not start automatically. Please touch the ON/OFF button to activate and deactivate the air freshener.



Cleaning and maintenance

Always pull out the electricity plug before cleaning and maintaining of the appliance.

The following operations must be carried out by competent and trained professionals!

In any case, it is best to contact our authorized service.

Removal of scale deposits in the steam generator

Depending on the hardness of the tap water the unit must be cleaned of limescale deposits every 5 to 10 months. After 250 working hours the unit will show you a message on the display "CALL SERVICE". You can continue working with EV ATLANTIS by unplugging the power cord from the electrical socket and plugging it back again, but it is necessary to contact your supplier in the next 100 working hours. EV ATLANTIS will show you a few more messages until you reach 350 working hours, then the maintenance must be done in order to activate the steam flow again.

Proceed as follows:

- ▶ Pull out the plug from the socket;
 - ▶ Wait until the EV ATLANTIS is cold;
 - ▶ Unscrew boiler cap (1) by using the boiler key included in the supply and pour the water out from the boiler;
 - ▶ Put 2 cups of fluid for maintenance in the steam boiler (use fluid for maintenance provided by our service. Fluid for maintenance will be charged additionally);
- ▶ Close the boiler again by using the screw. Watch if the screw seal lies in correct position;
 - ▶ Heat the appliance and after indication of the steam readiness disconnect the appliance from the electrical outlet;
 - ▶ After complete cooling of the appliance reopen the screw gate of the boiler (1) and pour out the water;
 - ▶ Close the boiler again using the screw. Watch if the screw seal lies in correct position;
 - ▶ Finished.



- ▶ Do not use any chemicals for cleaning of scale, either in normal operation;
- ▶ **Carrying out routine checks of inclusion items and electronics of the device by the employees of our service prolong significantly the lifetime of the device;**
- ▶ These checks are charged by the supplier.

Legal aspects



This user guide contains the information necessary for correct use, proper handling and skilled technical support of the machine.

Knowledge of and compliance with this guide is a condition for safe operation and safe maintenance of the machine.

Of course, this user guide cannot contain all possibilities for use.

If you need more information or have more questions, please contact us.

E V International Ltd.
Kostur 14A, BG-1618 Sofia
Phone: +359 2 400 77 36
Fax: +359 2 950 77 16
office@ev-international.com
www.ev-international.com

Disposal and recycling

The materials from which the device is made, must not be discarded. In order to remove them as waste contact public points for processing and recycling or the supplier.

According to Art.13 of the Law enforcement No 151 of July 25, 2005 Implementation of Directives 2002/95 /EU, 2002/96/EU and 2003/108/EU for reduction of the use of hazardous substances in electrical and electronic equipment and removal of waste.

Crossed bin symbol on the appliance means that at the end of its use, the product should be removed separately from the other waste.

You'll have to hand over the device, that will no longer be used in the centers suitable for separate collection of electrical and electronic waste or to return it in the shop in case of buying a new appliance of this type.

Proper separation of instruments that undergo recycling, preparation and disposal as waste, which does not harm the environment, helps to avoid possible negative environmental impacts and health. It also favors the reuse of materials from which the device is made.

Unlawful removal of the product as waste by the user is punished by criminal law enforcement measures under Law enforcement 22/1997 (Art. 50 and following of the Law enforcement No 22/1997).



Legal aspects



E V International Ltd., Kostur 14A, BG-1618 Sofia, declares on own responsibility that the device referred to in this declaration of conformity complies with the following safety requirements laid down in the Directives for the CE marking:

ELECTROMAGNETIC COMPATIBILITY AND ELECTRICAL SAFETY

2014/30/UE

- ▶ EN 55014-1:2017
- ▶ EN 55014-2:2015
- ▶ EN 61000-3-2:2014
- ▶ EN 61000-3-3:2013

Electric Heating Appliances

UL 499

Issued:2014/11/07

CSA C22.2 N.64.

Issued:2010/03/01 (R2014) Ed:7

and meets the next harmonized standards:

2014/35/UE

- ▶ IEC 60335-1:2010
- ▶ IEC 60335-1:2010/AMD1:2013
- ▶ IEC 60335-1:2010/AMD2:2016
- ▶ IEC 60335-2-54:2008
- ▶ IEC 60335-2-54:2008/AMD1:2015
- ▶ IEC 60335-2-54:2008/AMD2:2019



 100% VIRUCIDAL system against *
human CORONAVIRUS 229E,
based on the test
UNI EN ISO 16777: 2018

* EV ATLANTIS + SANIX + EV H₂O₂ Silver Bio

Maintenance



EV ATLANTIS



E V International Ltd.[®]
office@ev-international.com



www.ev-international.com

Made in Italy

